

EAGLE BASKET™

Fast Install. Quick Delivery.

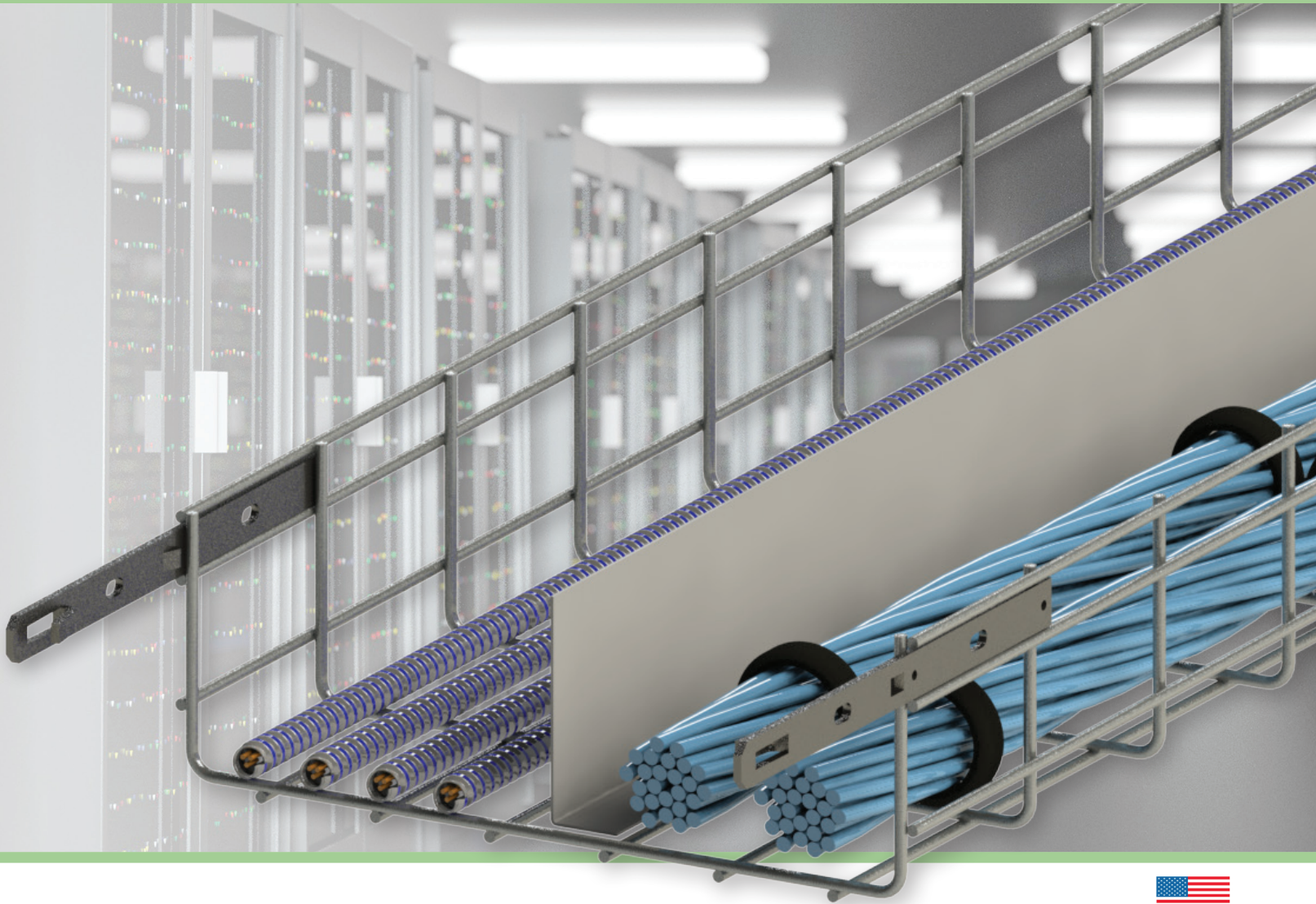

Atkore™
Cope

SOAR TO NEW HEIGHTS WITH EAGLE BASKET!

TJ COPE - THE INVENTOR OF CABLE TRAY

Since 1948, when TJ COPE introduced the first modular cable tray system, they have been the leader in cable management solutions. EAGLE BASKET™ is the newest addition to their innovative product offering, a wire basket solution which will provide end-users with unmatched quality, delivery, and customer satisfaction.

DESIGNED FOR YOU, BY YOU

EAGLE BASKET was designed and developed with one thing in mind – the customer! EAGLE BASKET is the ONLY zero-hardware solution in the cable management industry, minimizing installation time and costs. With 4 stocking locations across the U.S. and dedicated engineering services, COPE provides best-in-class delivery and customer experience.

PARTNERING FOR THE FUTURE

COPE, a part of Atkore™ is focused on developing new innovative products, product enhancements, and unrivaled service to the electrical raceway industry. Atkore is constantly looking for ways to improve existing products and embracing new cable management methods. Choose Atkore to be your wire and cable management partner for the future - building better together.



MARKETS SERVED

DATA CENTERS & FIBER OPTICS

Powder coated wire baskets are most often used in data centers to eliminate the risk of zinc whiskers getting into sensitive computer equipment. The open structure efficiency with the option of dropping cables out from any part of cable trays, make wire basket ideal for these applications.



COMMERCIAL & OFFICE

With its modern look and the option for custom colors, wire basket is a great solution for open office concept applications. The lightweight and high efficiency design minimize installation and operating costs.



INDUSTRIAL

With 2 stainless steel and a HDGAF (hot dipped galvanized after fabrication) finish, these wire baskets can withstand the most corrosive and demanding environments including food processing, salt/marine, and any outdoor applications.



HOSPITALS & SCHOOLS

The need for speedy installation and highly flexible wire basket system appeals to these applications which are often subject to modifications and expansion. Unlike cable tray, wire basket doesn't require custom ordered fittings and the extensive offering of accessories are perfectly suited for runway upgrades and growth.

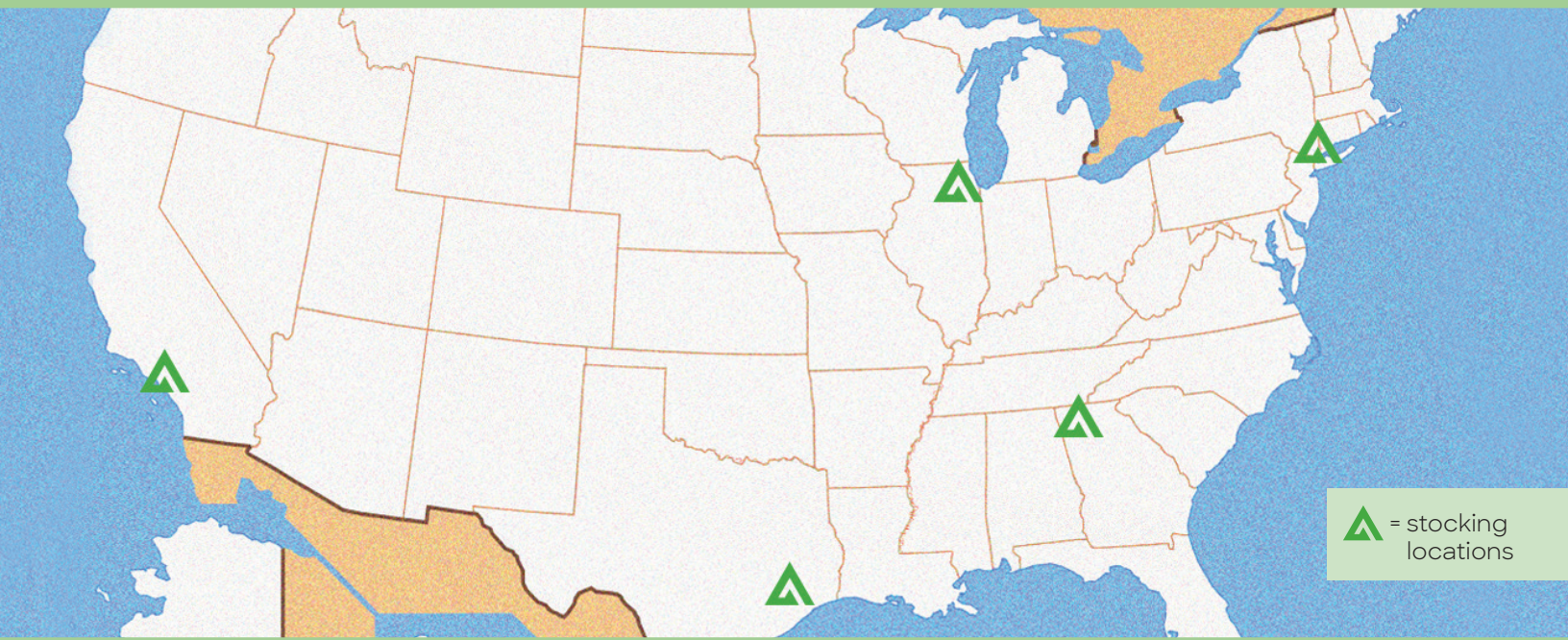

TABLE OF CONTENTS

INTRODUCTION	2
MARKETS SERVED	3
MADE IN THE USA.....	5
QUICK-LATCH	6
MATERIALS AND FINISHES	7
2" DEEP EAGLE BASKET.....	8
4" DEEP EAGLE BASKET.....	9
6" DEEP EAGLE BASKET	10
SPLICING.....	11-13
GROUNDING.....	14
COVERS, DIVIDERS, LINERS.....	15
MOUNTING (HANGERS, SUPPORTS, BRACKETS).....	16-21
GROUND / UNDERFLOOR SUPPORTS.....	22
ACCESSORIES	23-26
FITTING OVERVIEW / ASSEMBLY	27-31



MADE IN THE U.S.A.



AMERICAN MADE AND STOCKED ACROSS THE U.S.A. TO MEET YOUR NEEDS

EAGLE BASKET is a welded wire mesh cable management system produced from the highest quality steel wires, one of the strongest in the industry. The 2x4" mesh permits continuous airflow to prevent heat buildup as well as dust and other contaminants. The full line of QUICK-LATCH accessories is ideal for design-builds and expansion to existing grids, making installation fast and simple.

- Made in America – meets BUY AMERICA and BUY AMERICAN
- Manufactured by United Steelworkers of America
- Supports other Atkore brands
- Stocking locations across the U.S.A.
- Excludes some accessories

STANDARD BASKET SIZE CHART - ADDITIONAL SIZES AVAILABLE UPON REQUEST

2" DEPTH	4" DEPTH	6" DEPTH
EGL2-02SL-120	EGL4-04SL-120	EGL6-06SL-120
EGL2-04SL-120	EGL4-06SL-120	EGL6-08SL-120
EGL2-06SL-120	EGL4-08SL-120	EGL6-12SL-120
EGL2-08SL-120	EGL4-12SL-120	EGL6-16SL-120
EGL2-12SL-120	EGL4-16SL-120	EGL6-18SL-120
EGL2-16SL-120	EGL4-18SL-120	EGL6-20SL-120
EGL2-18SL-120	EGL4-20SL-120	EGL6-24SL-120
EGL2-20SL-120	EGL4-24SL-120	
EGL2-24SL-120		

QUICK-LATCH™

THE INDUSTRY'S ONLY ZERO-HARDWARE SOLUTION FOR ALL TRAY SIZES

The QUICK-LATCH™ splicing system makes connecting EAGLE BASKET fast and easy. The QUICK-LATCH or self-splicing bars come pre-installed on ALL wire basket straight lengths, eliminating the need for nut and bolt type connections. The AUTOLOCK is built into the QUICK-LATCH which locks the trays into place for a secure connection. For proper grounding of wire basket please refer to page 14.

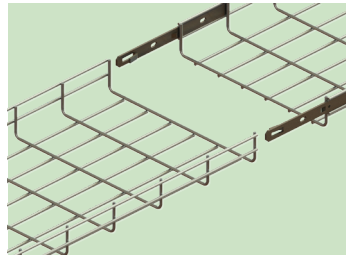
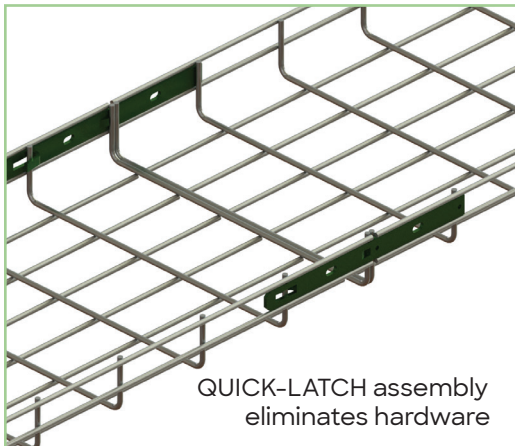

Step 1

Align the trays as shown

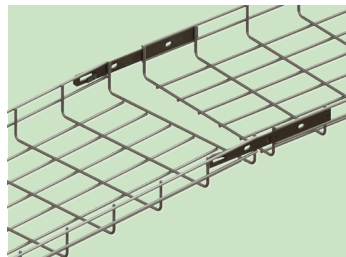

Step 2

While raising the edge of the tray with QUICK-LATCH slide the tray forward but do not engage the AUTO-LOCK

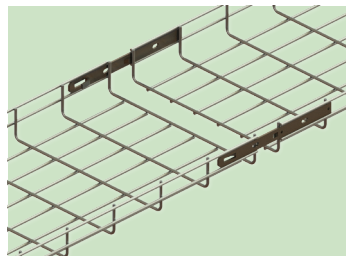

Step 3

Lower the edge of the QUICK-LATCH over the back edge of the tray

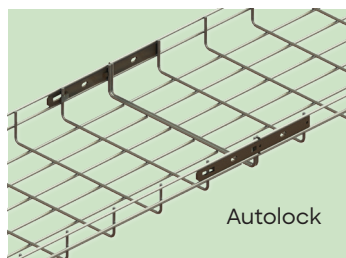

Step 4

Slide the tray forward to engage QUICK-LATCH and AUTO-LOCK

Splice straight lengths for field cuts with zero hardware



EAGLE BASKET MATERIALS AND FINISHES

EAGLE BASKET is offered in a wide variety of materials and finishes to meet all of your environmental and aesthetic requirements.

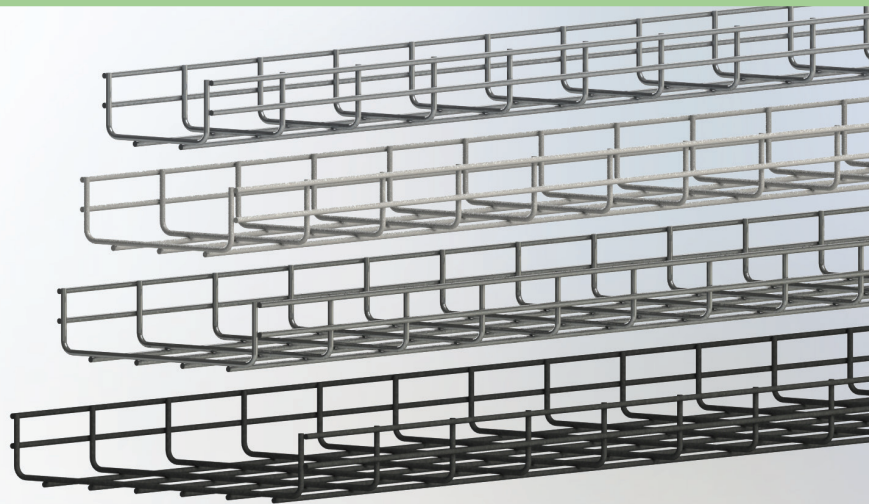

SUFFIX	MATERIAL	FINISH	CONTROLLED INTERIOR	EXTERIOR	OIL/GAS PETROCHEMICAL	FOOD PROCESSING	HIGHLY CORROSIVE APPLICATIONS
No suffix needed	ASTM A 510 GRADE 1008	Electroplated zinc galvanized after fabrication ASTM B633	X				
HDG	ASTM A 510 GRADE 1008	Hot Dipped Galvanized after fabrication ASTM 123		X	X		
304	304L Stainless Steel	ASTM A580		X	X	X	
316	316L Stainless Steel	ASTM A580		X	X	X	X
PCW	ASTM A 510 GRADE 1008	White powder coat finish after application	X				
PCB	ASTM A 510 GRADE 1008	Black powder coat finish after application	X				
PC(X)	ASTM A 510 GRADE 1008	Custom powder coat finish after application e.g. PCY = Powder coat yellow	X				

EAGLE BASKET PRODUCT CODE - USE WHEN ORDERING OR SPECIFYING EAGLE BASKET

TRAY TYPE	LOAD DEPTH (in)		WIDTH (in)	STRAIGHT LENGTH		LENGTH (in)
EGL	H	-	WW	SL	-	120

For example: CAT2-24SL-120 is the product code for 2" load depth, 24" wide Eagle Basket

EAGLE BASKET - 2" LOAD DEPTH

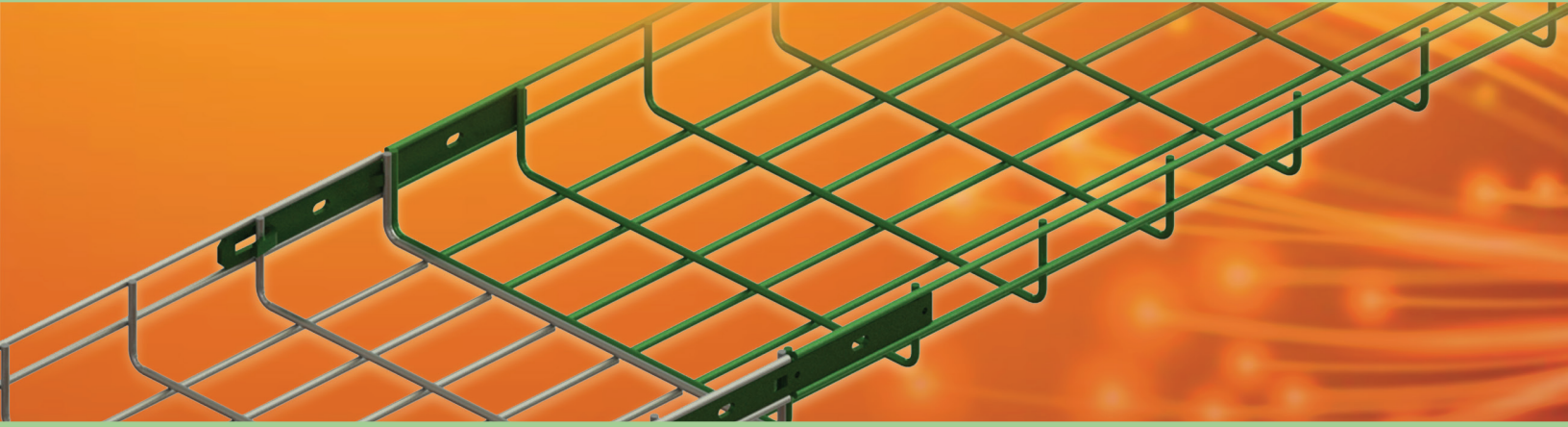

FEATURES

- Double rod reinforced tray is 2" high
- Standard length of tray is 10'
- Additional widths available upon request
- Standard finish is electro-galvanized (EG)
- Zero hardware to connect straight lengths
- For continuous grounding use EGL-GC
 - See page 14



EGL2-(W)SL

APPROVALS		PART DESCRIPTION	NOMINAL WIDTH	Wire Diameter (in)	Weight (piece)	Loading (lb/ft)				
UL	cUL					5' Span	6' Span	8' Span	9' Span	
			EGL2-02SL-120	2" (50 mm)	0.197	4.6	60	42	23	19
			EGL2-04SL-120	4" (100 mm)	0.197	6.8	60	42	23	19
			EGL2-06SL-120	6" (150 mm)	0.197	8.0	60	42	23	19
			EGL2-08SL-120	8" (200 mm)	0.197	9.3	89	62	35	27
			EGL2-12SL-120	12" (300 mm)	0.197	14.5	89	62	35	27
			EGL2-16SL-120	16" (400 mm)	0.197	25.3	149	103	58	46
			EGL2-18SL-120	18" (450 mm)	0.197	27.6	149	103	58	46
			EGL2-20SL-120	20" (500 mm)	0.197	29.8	149	103	58	46
			EGL2-24SL-120	24" (600 mm)	0.197	34.3	149	103	58	46

EAGLE BASKET - 4" LOAD DEPTH

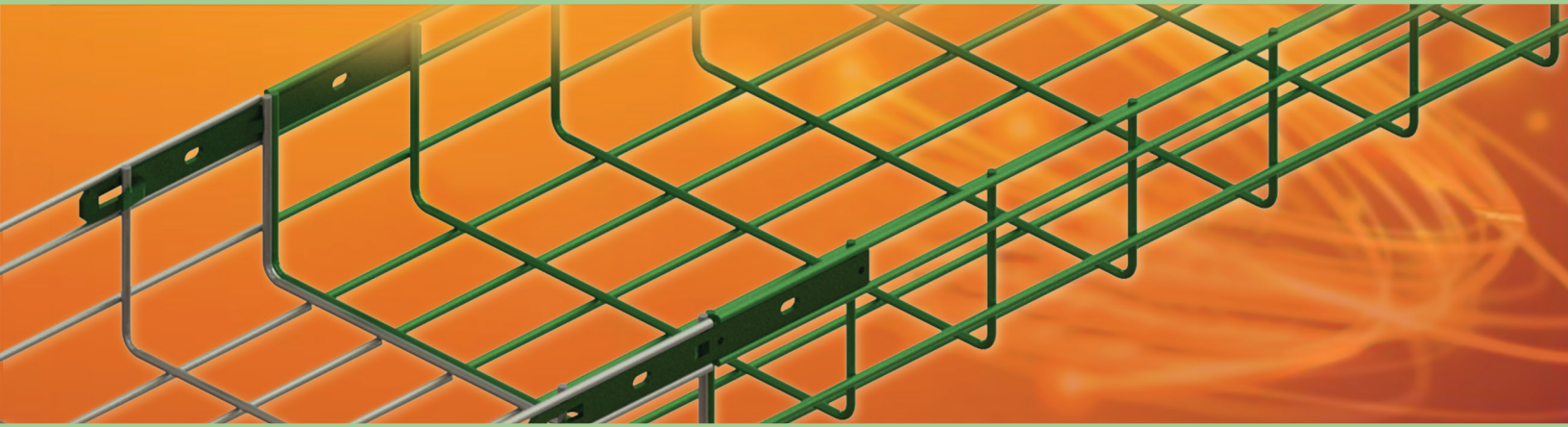

FEATURES

- Triple rod reinforced tray is 4" high
- Standard length of tray is 10'
- Additional widths available upon request
- Standard finish is electro-galvanized (EG)
- Zero hardware to connect straight lengths
- For continuous grounding use EGL-GC
 - See page 14



EGL4-(W)SL

APPROVALS		PART DESCRIPTION	NOMINAL WIDTH	Wire Diameter (in)	Weight (piece)	Loading (lb/ft)				
UL	cUL					5' Span	6' Span	8' Span	9' Span	
			EGL4-04SL-120	4" (100 mm)	0.197	9.3	108	75	42	33
			EGL4-06SL-120	6" (150 mm)	0.197	11.9	108	75	42	33
			EGL4-08SL-120	8" (200 mm)	0.197	14.5	108	75	42	33
			EGL4-12SL-120	12" (300 mm)	0.197	25.3	182	127	71	56
			EGL4-16SL-120	16" (400 mm)	0.197	29.8	182	127	71	56
			EGL4-18SL-120	18" (450 mm)	0.197	32.0	182	127	71	56
			EGL4-20SL-120	20" (500 mm)	0.197	34.3	182	127	71	56
			EGL4-24SL-120	24" (600 mm)	0.197	38.8	182	127	71	56

EAGLE BASKET - 6" LOAD DEPTH



FEATURES

- Quadruple rod reinforced tray is 6" high
- Standard length of tray is 10'
- Additional widths available upon request
- Standard finish is electro-galvanized (EG)
- Zero hardware to connect straight lengths
- For continuous grounding use EGL-GC
 - See page 14



EGL6-(W)SL

APPROVALS		PART DESCRIPTION	NOMINAL WIDTH	Wire Diameter (in)	Weight (piece)	Loading (lb/ft)				
UL	cUL					5' Span	6' Span	8' Span	9' Span	
			EGL6-06SL-120	6" (150 mm)	0.197	8.0	60	42	23	19
			EGL6-08SL-120	8" (200 mm)	0.197	25.3	235	163	92	73
			EGL6-12SL-120	12" (300 mm)	0.197	29.8	235	163	92	73
			EGL6-16SL-120	16" (400 mm)	0.197	34.3	235	163	92	73
			EGL6-18SL-120	18" (450 mm)	0.197	36.4	235	163	92	73
			EGL6-20SL-120	20" (500 mm)	0.197	38.8	235	163	92	73
			EGL6-24SL-120	24" (600 mm)	0.197	48.4	235	163	92	73



SPLICING

QUICK-LATCH

- QUICK-LATCH assembles straights at field cuts
- No hardware required
- UL approved as grounding path when used with EGL-GC and EG-CBN
- Sold individually

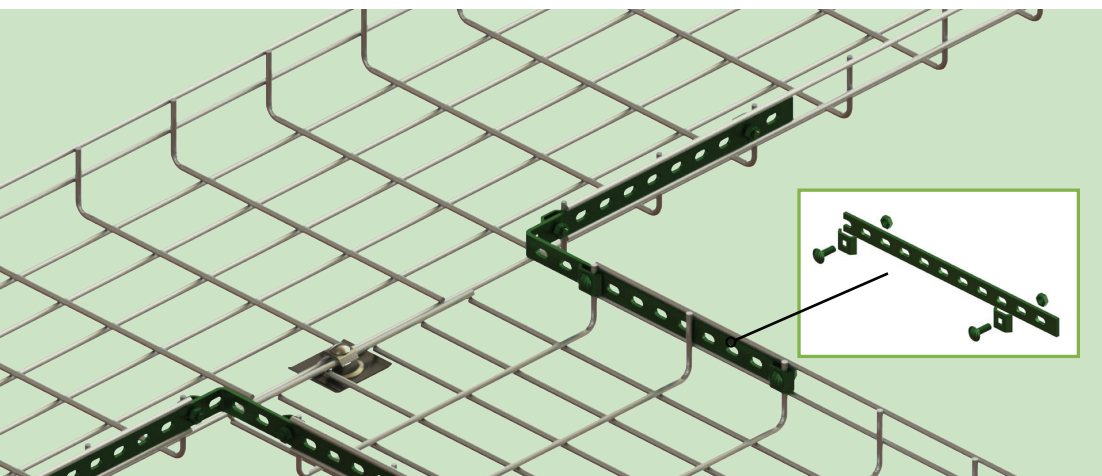
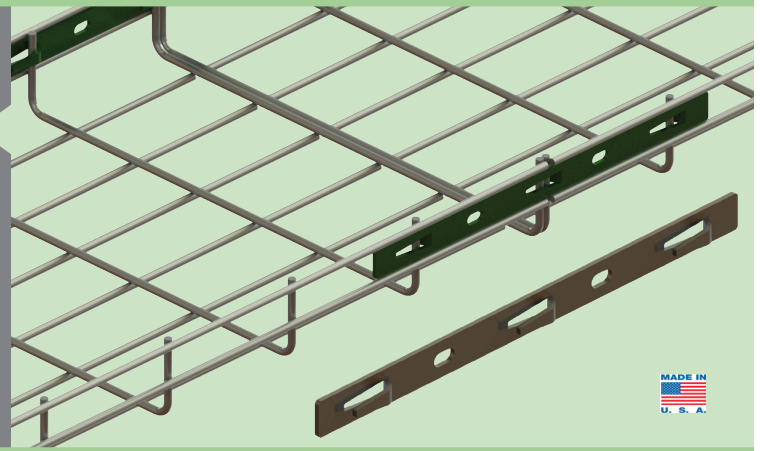

Notes:

1. Always place nut on outside of tray
2. For use with EGL2, EGL4 & EGL6 basket
3. Used for tees which require a heavier support
4. These bars are field cut to appropriate length

FITTING SPLICES

44" T-BAR T-BAR

WEIGHT: 1.43/each

- T-bar connector is $\frac{3}{4}$ " x 44" long
- Connect using CH3 (sold separately)
- Bend 90° for use as an angle connector

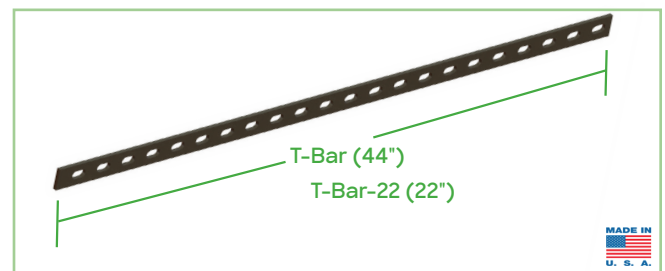

22" T-BAR-22 T-BAR-22

WEIGHT: .715/each

- T-BAR-22 connector is $\frac{3}{4}$ " x 22" long
- Connect using CH3 (sold separately)

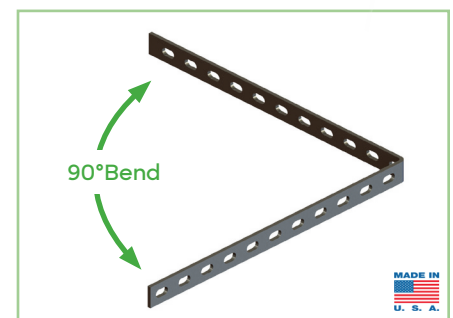

CONNECTOR HARDWARE OVERVIEW

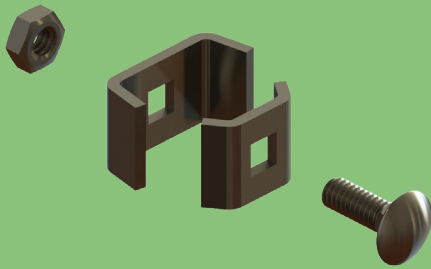

CH1

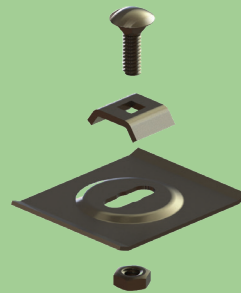

CH2

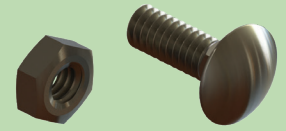

CH3

FITTING HARDWARE

SHORT RADIUS 90 KIT

- Standard bar connector is $1\frac{3}{16}$ " x $1\frac{1}{16}$ "
- Standard finish is electro-galvanized (EG)
- Sold in packs of 10

NOTE: Always place nut on outside of tray



CH1

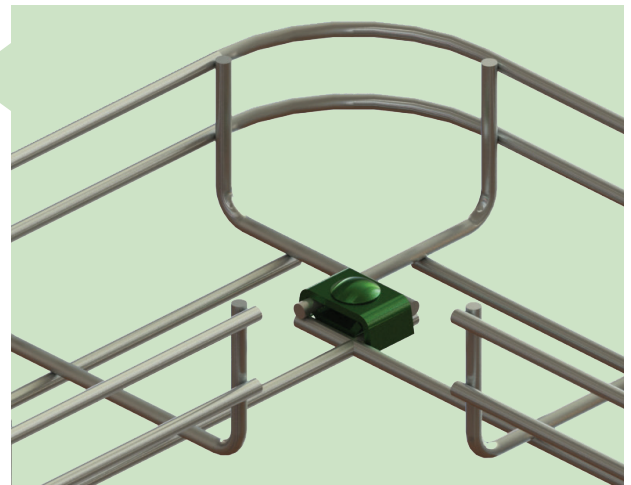

REDUCER KIT

- Bottom connector is 2" x $2\frac{3}{8}$ "
- Standard finish is electro-galvanized (EG)
- Sold in packs of 10
- (EG-CBN connector hardware included)

NOTE: Always place nut on outside of tray

CH2

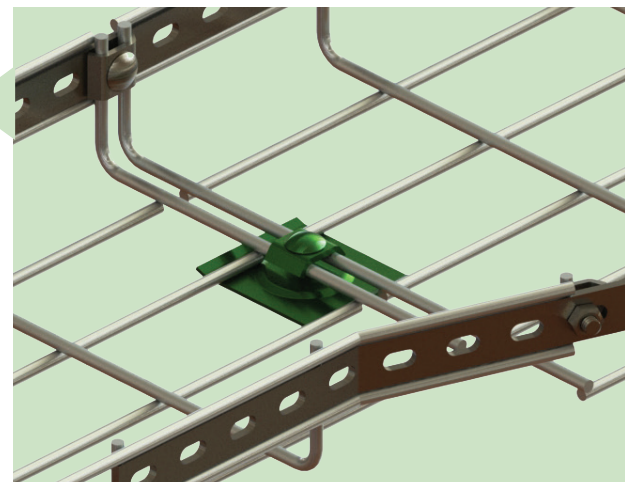



FITTING HARDWARE

TEE & CROSS KIT

CH3

- Universal connector is 1 $\frac{1}{16}$ " x 1 $\frac{5}{16}$ "
- Standard finish is electro-galvanized (EG)
- Sold in packs of 10
- EG-CBN connector hardware included

NOTE: Always place nut on outside of tray

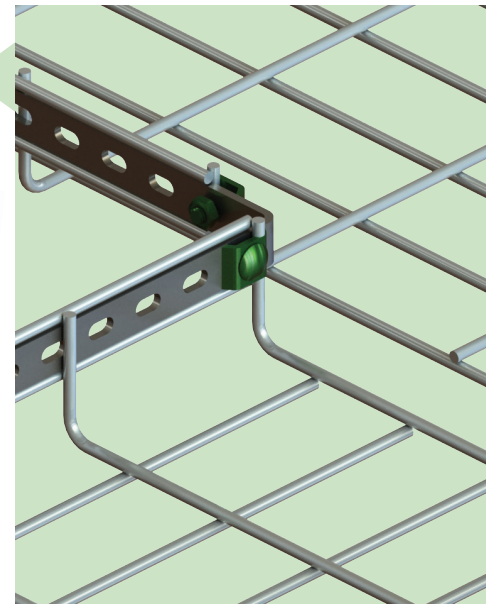

HARDWARE

EG-CBN

- 1/4"-20 X 3/4" Carriage bolt
- 1/4"-20 Hex head nut
- Standard finish is electro-galvanized
- Sold in packs of 10

NOTE: Always place nut on outside of tray



BOTTOM CLIP 10 PACK

BOTTOM-CLIP

- Can be used as a hold down clip to relay racks and strut
- Sold in packs of 10
- EG-CBN sold separately
- Up to 1/4" diameter hardware for securing to strut

NOTE: Always place nut on outside of tray

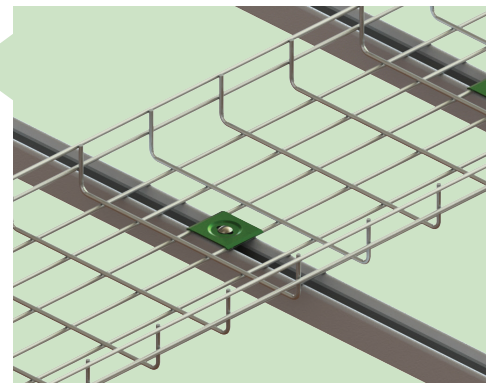
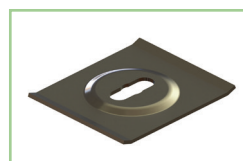

GROUNDING

UL CLASSIFIED SYSTEMS

COPE Wire Basket systems meet the UL Classification

- Any non-conductive coating to wire basket must be removed by the contractor/ end-user to maintain electrical continuity

STRAIGHT SECTIONS - The grounding of two straight sections requires the use of:

- (2) EGL-GC
- (2) EG-CBN

These items consist of grounding clips and the appropriate hardware for connecting to trays. One clip should be placed on both sides of the tray, attached at the QUICK-LATCH bar.

FITTINGS – Grounding a fitting requires special attention. Typically, fittings are fabricated in the field by cutting straight sections, thus altering the cross sectional area of the tray. A bonding jumper, and/ or a T-BAR, along with the appropriate hardware must be used on either side of the fitting to ensure electrical continuity.



GROUNDING CLIP EGL-GC

- Standard finish is pregalvanized (PG)
- Sold in packs of 10
- Connection to splice bars requires a nut and bolt assembly (EG-CBN) purchased separately
- Use on both sides of tray

NOTE: Always place nut on outside of tray

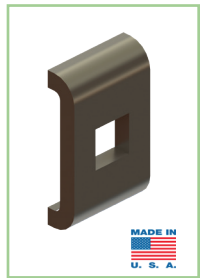

GROUNDING WIRE SPLIT BOLT SPLIT-BOLT

- Split bolts are utilized for the attachment of a separate ground wire.
- Use with #6 AWG Ground Conductor

NOTE: Always place nut on outside of tray CAT-GC's must be installed if the tray is to be utilized as an equipment ground conductor.

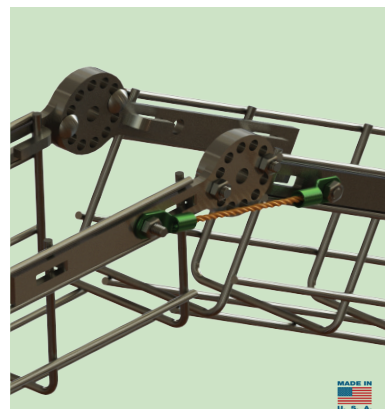
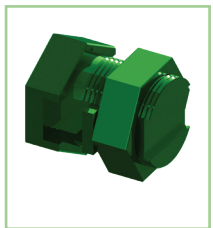

BONDING JUMPER CBJ-C

- Order EGL-GC and EG-CBN separately for installation



EAGLE BASKET COVERS / LINERS

COVER EGL-CVR-(WW)

- Standard finish is pregalvanized (PG)
- Length is 10'
- Easy mounting using the TAB feature to fasten the cover to basket

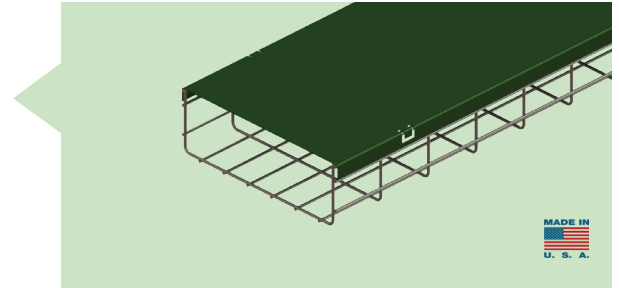

LINER EGL-LINER-(WW)

- Standard finish is pregalvanized (PG)
- Length is 10'
- Easy mounting using the TAB feature to fasten the liner to basket

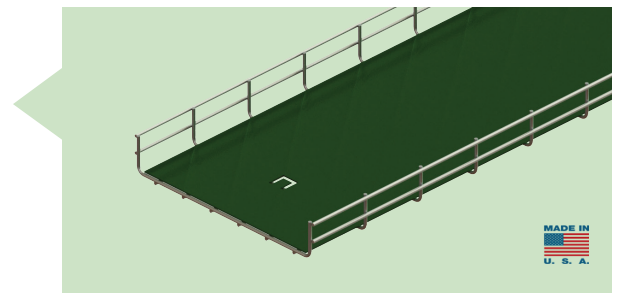

EAGLE BASKET DIVIDERS

DIVIDER EGL(H)-01SB-120

- Standard finish is pregalvanized (PG)
- Easy mounting using the LANCE feature to fasten the divider to basket
- Cut "V" into bottom flange to make barriers for horizontal fittings

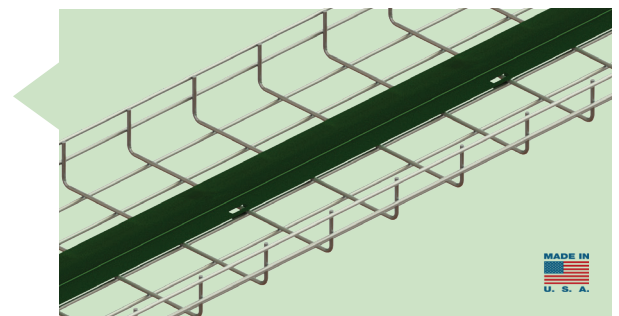

PART	"H" DIMENSION (in)	WEIGHT (lb)
EGL2-01SB-120	1.60	0.6
EGL4-01SB-120	3.60	1.0
EGL6-01SB-120	5.60	1.4

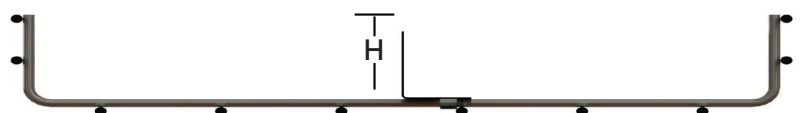

EAGLE BASKET MOUNTING

DROP ROD CLIPS

SIDE-DROP ROD CLIP EGL-SIDE-DRC

WEIGHT: 0.13 lb/each

- Standard finish is pregalvanized (PG)
- 0.08 Bracket thickness
- For all widths of tray

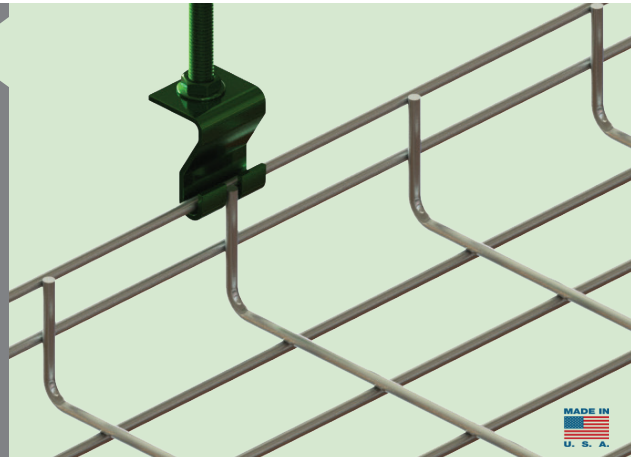
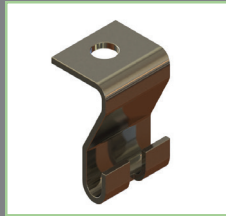

4"-6" CENTER-DROP ROD CLIP

EGL-1x6-DRC

WEIGHT: 0.12 lb/each

- Standard is finish pregalvanized (PG)
- 0.11" Bracket thickness
- For all 4" and 6" Width tray
- Easy mounting of cable trays using the LANCE feature to fasten the tray to hanger

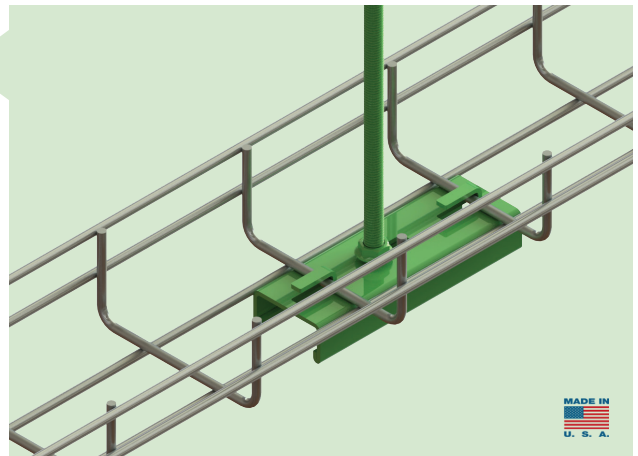

8"-12" CENTER-DROP ROD CLIP

EGL-2x8-DRC

WEIGHT: 0.40 lb/each

- Standard is finish pregalvanized (PG)
- 0.11" Bracket thickness
- For all 8" and 12" Width tray
- Easy mounting of cable tray using the LANCE feature to fasten the tray to hanger

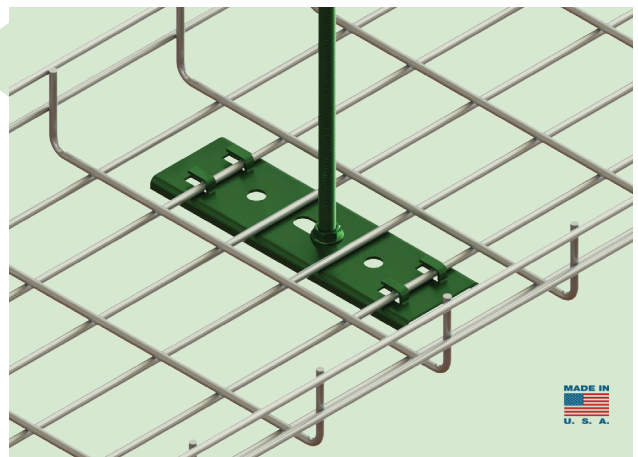
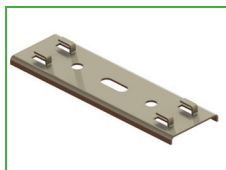

EAGLE BASKET MOUNTING HANGERS

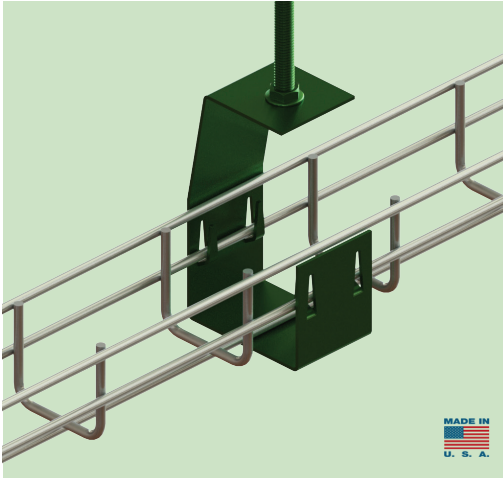

2" BASKET HANGER EGL-HGR-2

- Standard finish is pregalvanized (PG)
- Ceiling or center hung with threaded rod
- Easy mounting of cable tray using the LANCE feature to fasten the tray to hanger

NOTE: For use with EGL2-02SL-120 only

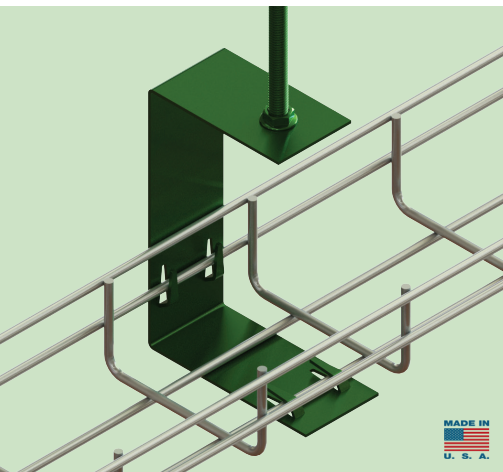

4" BASKET HANGER EGL-HGR-4

- Standard finish is pregalvanized (PG)
- Ceiling or center hung with threaded rod
- Easy mounting of cable tray using the LANCE feature to fasten the tray to hanger

NOTE: For use with EGL2-04SL-120 only

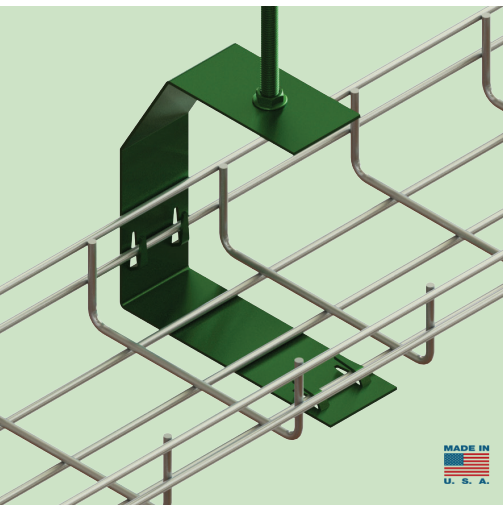

6" BASKET HANGER EGL-HGR-6

- Standard finish is pregalvanized (PG)
- Ceiling or center hung with threaded rod
- Easy mounting of cable tray using the LANCE feature to fasten the tray to hanger

NOTE: For use with EGL2-06SL-120 only



EAGLE BASKET MOUNTING SUPPORTS

MEDIUM SUPPORT BRACKET

EGL-MSB-(WW)

- 1 $\frac{5}{8}$ " x 1 $\frac{3}{16}$ " lanced strut
- Standard finish is pregalvanized (PG)
- Used for trapeze and center hung supports
- Easy mounting of cable tray using the LANCE feature to fasten the basket to support

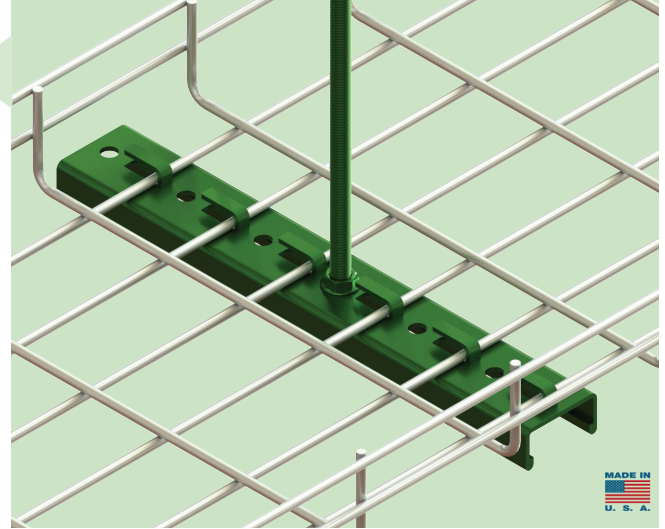

HEAVY-DUTY SUPPORT BRACKET

EGL-HSB-(WW)

- 1 $\frac{5}{8}$ " x 1 $\frac{1}{2}$ " lanced strut
- Standard finish is pregalvanized (PG)
- Used for trapeze and center hung supports
- Easy mounting of cable tray using the LANCE feature to fasten the tray to support

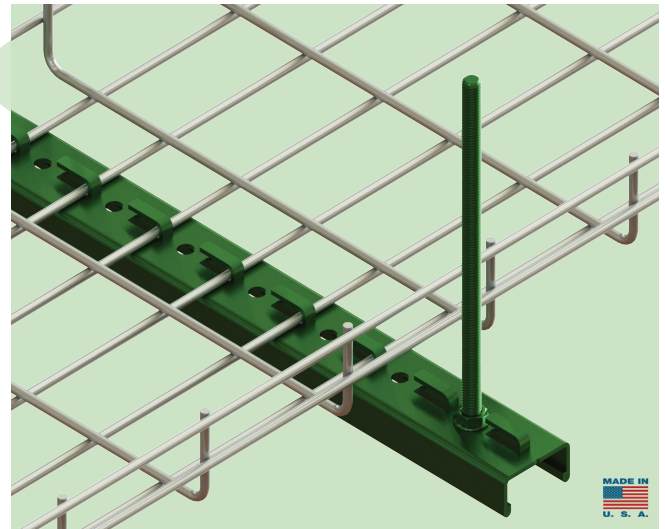
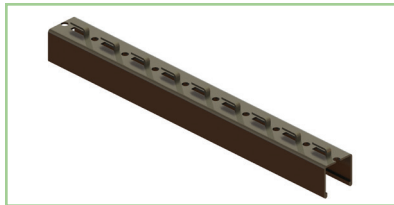

EGL-MSB-(WW)

EAGLE BASKET WIDTH (in)	TRAPEZE	CENTER HUNG
8	EGL-MSB-14	EGL-MSB-09
12	EGL-MSB-18	EGL-MSB-13
16	EGL-MSB-22	EGL-MSB-17
18	EGL-MSB-24	EGL-MSB-19
20	EGL-MSB-26	EGL-MSB-21
24	EGL-MSB-30	EGL-MSB-25

EGL-HSB-(WW)

EAGLE BASKET WIDTH (in)	TRAPEZE	CENTER HUNG
8	EGL-HSB-14	EGL-HSB-09
12	EGL-HSB-18	EGL-HSB-13
16	EGL-HSB-22	EGL-HSB-17
18	EGL-HSB-24	EGL-HSB-19
20	EGL-HSB-26	EGL-HSB-21
24	EGL-HSB-30	EGL-HSB-25



WALL BRACKETS

MEDIUM SUPPORT BRACKET

EGL-MWSB-(WW)

- 1⁵/₈" x 1³/₁₆" lanced strut
- Standard finish is pregalvanized (PG)
- Used for trapeze and center hung supports
- Easy mounting of cable tray using the LANCE feature to fasten the basket to bracket



HEAVY-DUTY SUPPORT BRACKET

EGL-HWSB-(WW)

- 1⁵/₈" x 1⁵/₈" lanced strut
- Standard finish is pregalvanized (PG)
- Used for trapeze and center hung supports
- Easy mounting of cable tray using the LANCE feature to fasten the basket to bracket

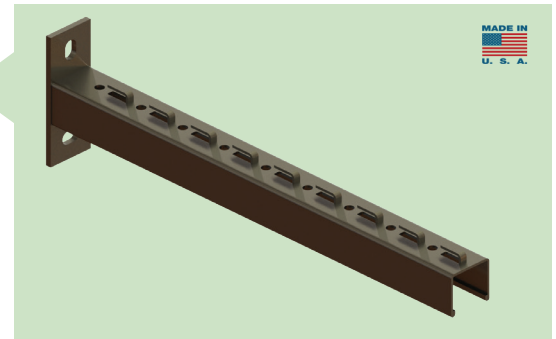

EGL-MWSB-(WW) & EGL-HWSB-(WW)

PART NO.	CHANNEL SIZE (in)	TRAY WIDTH (W) (in)	LENGTH (L) (in)	WEIGHT (lb)	LOAD (lb)
EGL-MWSB-06	1-5/8" X 13/16"	6	8	1.3	270
EGL-MWSB-08	1-5/8" X 13/16"	8	10	1.5	225
EGL-MWSB-12	1-5/8" X 13/16"	12	14	1.9	157
EGL-HWSB-08	1-5/8" X 1-5/8"	8	10	1.9	562
EGL-HWSB-12	1-5/8" X 1-5/8"	12	14	2.5	450
EGL-HWSB-16	1-5/8" X 1-5/8"	16	18	2.8	350
EGL-HWSB-18	1-5/8" X 1-5/8"	18	20	3	337
EGL-HWSB-20	1-5/8" X 1-5/8"	20	22	3.6	292
EGL-HWSB-24	1-5/8" X 1-5/8"	24	26	4.1	247

EAGLE BASKET MOUNTING BRACKETS

WALL BRACKET EGL-WC-2

- Standard finish is pregalvanized (PG)
- Easy mounting of cable tray using the LANCE feature to fasten the basket to bracket

NOTE: For use with EGL2-02SL-120 only

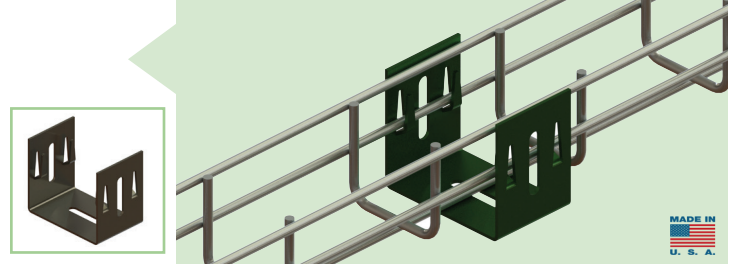

CEILING CLIP EGL-CCA-(WW)

- For attaching tray to ceiling
- Standard finish is pregalvanized (PF)
- Easy mounting of cable tray using the LANCE feature to fasten the tray to the supports

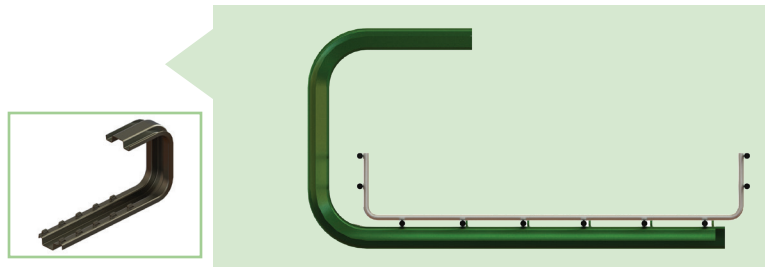

WALL CLIP EGL-CPA-(WW)

- For attaching tray to wall
- Standard finish is pregalvanized (PG)
- Easy mounting of cable tray using the LANCE feature to fasten the tray to the supports

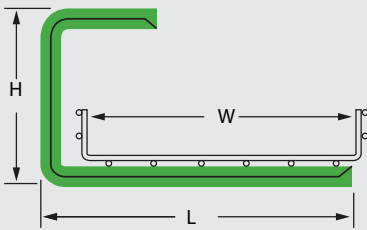
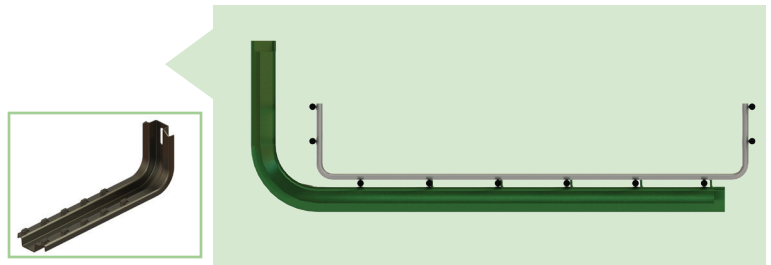

EGL-CCA-(WW)

PART NO.	TRAY SIZE (in)	HEIGHT (H) (in)	LENGTH (L) (in)	WEIGHT (lb)	LOAD (lb)
EGL-CCA-04	4	7	6	1.3	270
EGL-CCA-06	6	7	8	1.5	225
EGL-CCA-08	8	7	10	1.7	202
EGL-CCA-12	12	7	14	2.0	180
EGL-CCA-16	16	7	18	2.3	90

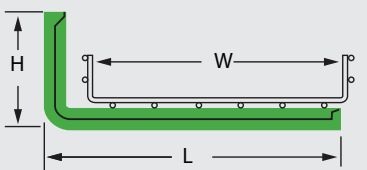

EGL-CPA-(WW)

PART NO.	TRAY SIZE (in)	HEIGHT (H) (in)	LENGTH (L) (in)	WEIGHT (lb)	LOAD (lb)
EGL-CPA-06	6	5	8	1.0	337
EGL-CPA-08	8	5	10	1.1	225
EGL-CPA-12	12	5	14	1.5	202
EGL-CPA-16	16	5	18	1.8	90

GROUND & UNDERFLOOR SUPPORTS

EAGLE BASKET FLOOR SUPPORT

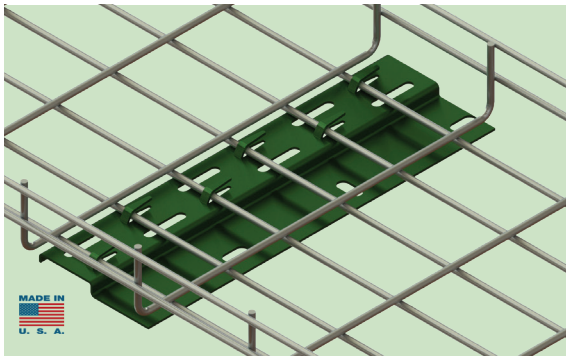

ZED BRACKETS

EGL-ZBAR-WW

- ZED floor or wall mounted supports
- Pre-cut to length of wire basket width (see chart below)
- Standard finish is pregalvanized (PF)
- Easy mounting of cable tray using the LANCE feature to fasten the tray to the supports

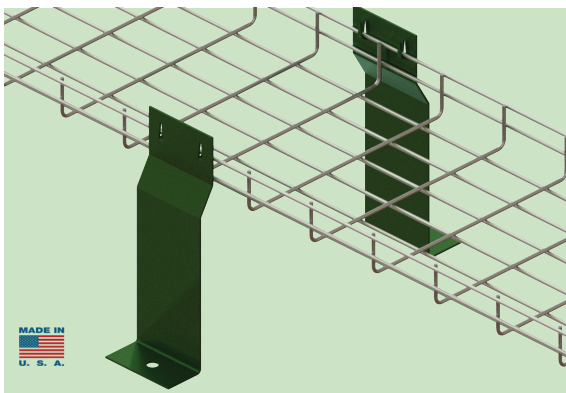
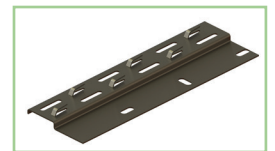

FLOOR SUPPORT

EGL-FLR-SPRT-(HH)

- Supports basket directly above floor
- Elevation (HH), as specified by customer - 24" Maximum
- Floor connection hardware not included
- Easy mounting of cable tray using the LANCE feature to fasten the tray to the supports

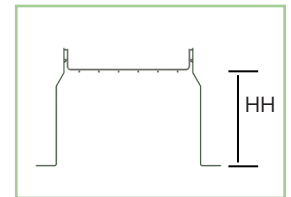

PART NO.	Basket Width (in)	L Dimension (in)
EGL-ZBAR-04	4	4
EGL-ZBAR-06	6	6
EGL-ZBAR-08	8	8
EGL-ZBAR-12	12	12
EGL-ZBAR-16	16	16
EGL-ZBAR-18	18	18
EGL-ZBAR-20	20	20
EGL-ZBAR-24	24	24



GROUND & UNDERFLOOR SUPPORTS

PEDESTAL BRACKETS & KIT

6" PEDESTAL BRACKET

EGL-PED-06

- Channels used on pedestals for raised floor
- Attach to pedestal using U-Bolt & nuts (included)
- Easy mounting of cable tray using the LANCE feature to fasten the tray to the channel

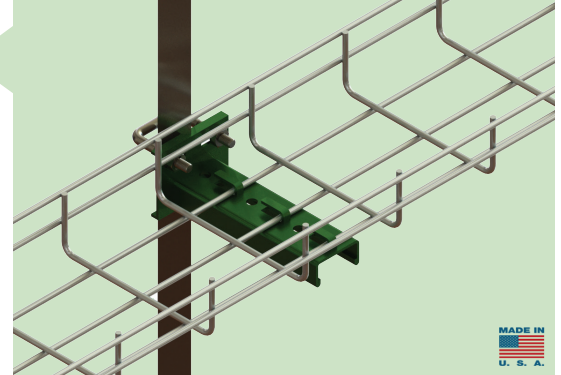
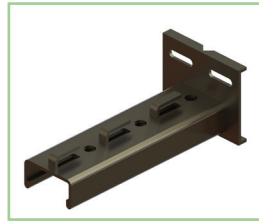

12" PEDESTAL BRACKET

EGL-PED-12

- Channels used on pedestals for raised floor
- Attach to pedestal using U-Bolt & nuts (included)
- Easy mounting of cable tray using the LANCE feature to fasten the tray to the channel

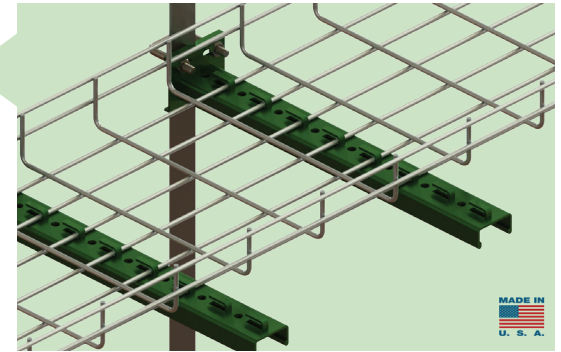
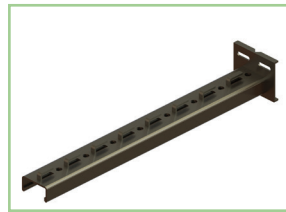

PEDESTAL KIT

EGL-PED-KIT

- Channels used on pedestals for raised floor
- Attach to pedestal using U-Bolt & nuts (included)
- Easy mounting of cable tray using the LANCE feature to fasten the tray to the channel

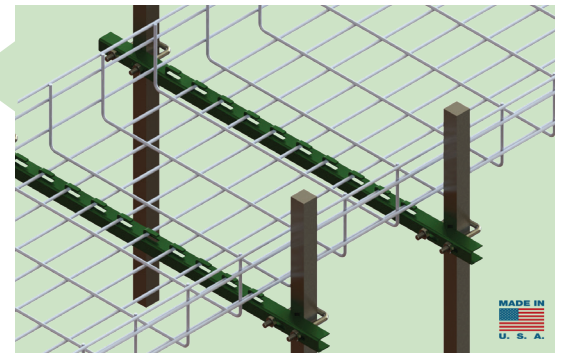

EGL-PED

CATALOG NO.	TRAY WIDTH (in)
CAT-PED-06	UP TO 8"
CAT-PED-12	UP TO 12"
CAT-PED-KIT	UP TO 24"

EAGLE BASKET ACCESSORIES

DROPOUTS

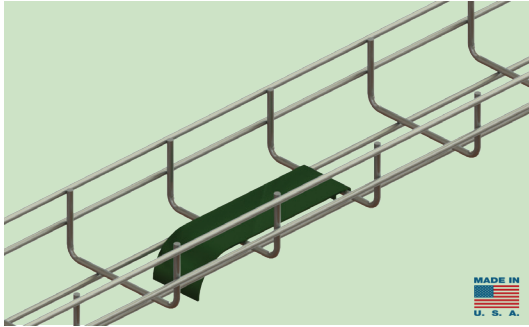

UNIVERSAL DROPOUT

EGL-UNI-DO

- Standard finish is pregalvanized (PG)
- EGL-UNI-DO can be used in any 2"x4" mesh opening or as a "side-out"
- Easy mounting using the LANCE feature to fasten the dropout to the tray

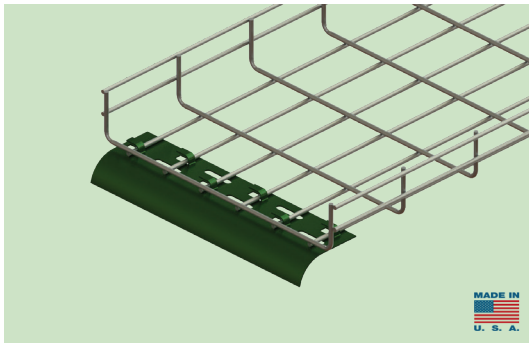

WATERFALL DROPOUT

EGL-(WW)DO

- Standard finish is pregalvanized (PG)
- EGL-UNI-DO can be use in any 2"x4" mesh opening or as a "side-out"
- Easy mounting using the LANCE feature to fasten the dropout to the tray
- Contact for additional sizes

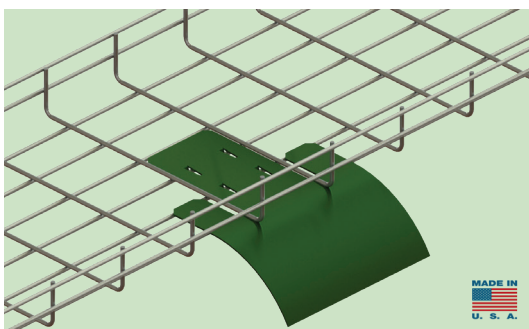
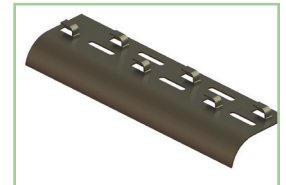

SIDE DROPOUT

EGL-(WW)SDO

- Standard finish is pregalvanized (PG)
- Drop cables out from side of basket
- Easy mounting using the LANCE feature to fasten the dropout to the tray
- Contact for additional sizes

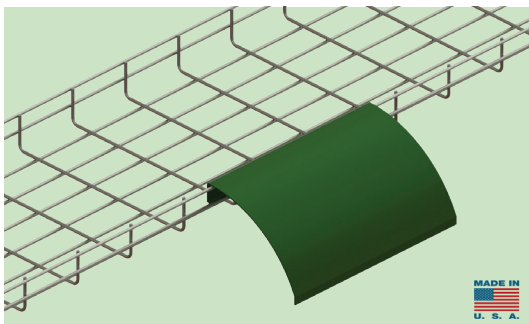

OVER-THE-TOP DROPOUT

EGL-(WW)TDO

- Standard finish is pregalvanized (PG)
- Drop cables out from the top of the basket
- Easy mounting using the LANCE feature to fasten the dropout to the tray
- Contact for additional sizes

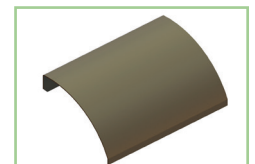

EAGLE BASKET ACCESSORIES

TEE BRIDGE

EGL-(WW)TBR

- Allows for organization and separation of cables in horizontal tee fittings
- Standard finish is pregalvanized (PG)
- Available in reducing options
- Contact for additional sizes

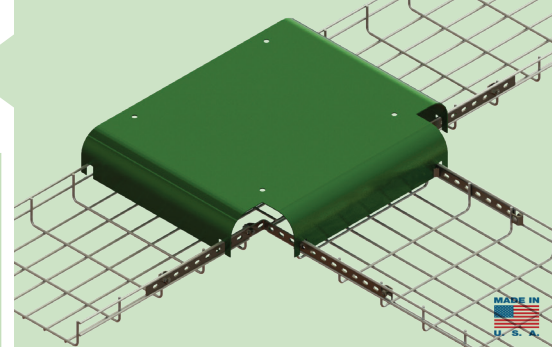
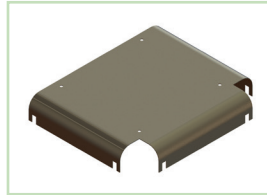

CROSS BRIDGE

EGL-(WW)XBR

- Allows for organization and separation of cables in horizontal cross fittings
- Standard finish is pregalvanized (PG)
- Available in reducing options
- Contact for additional sizes

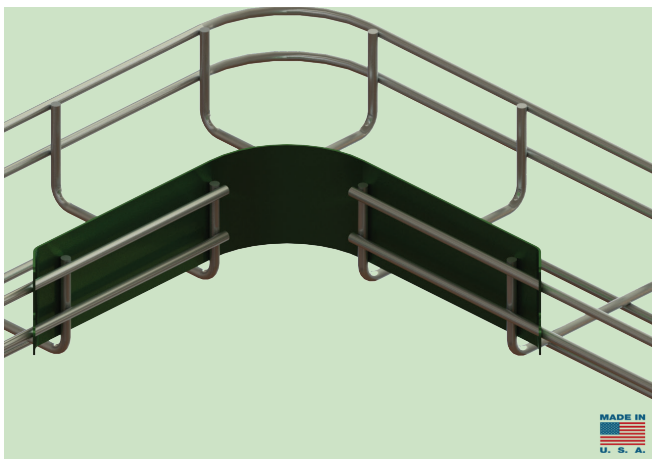
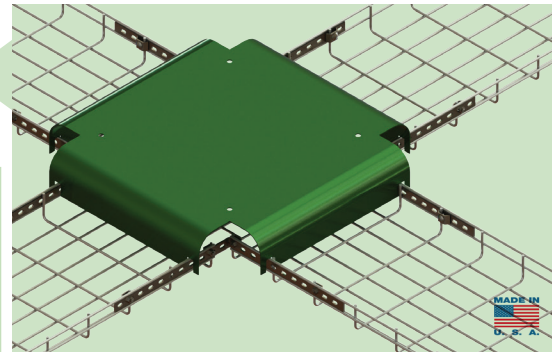
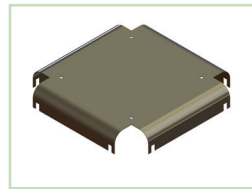

RADIUS SHIELD EGL(H)-RADIUS

- Used to maintain cable bend radius when routing or pulling cables through fittings
- Standard finish is pregalvanized (PG)
- For short radius horizontal bends, long radius available upon request

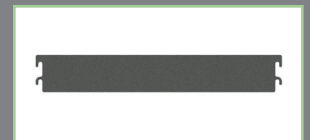

EAGLE BASKET ACCESSORIES

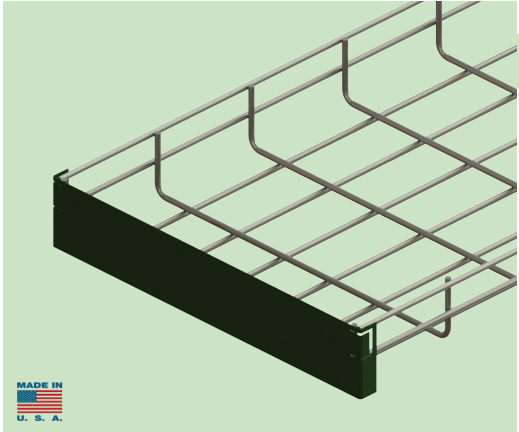

BLIND END

EGL(H)-(WW)BE

- Forms closure for EAGLE BASKET ends
- Standard finish is pregalvanized (PG)
- Easy mounting using the TAB feature to fasten the blind end to the tray.

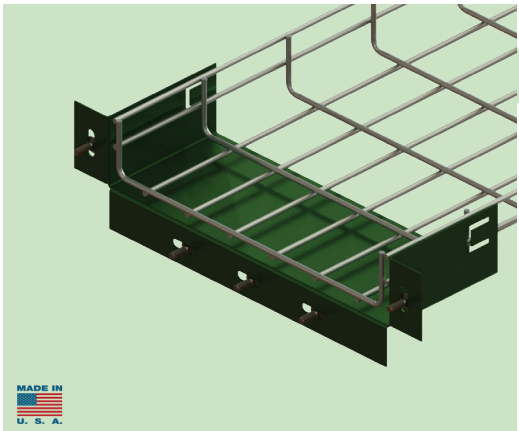
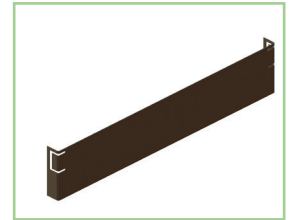

BOX CONNECTOR

EGL(H)-(WW)CB

- Connects EAGLE BASKET to box devices
- Easy mounting using the TAB feature to fasten the box connector to the tray
- Standard finish is pregalvanized (PG)
- Standard use per box connector is:
(5) EG-CBN – sold separately to connect to box device.

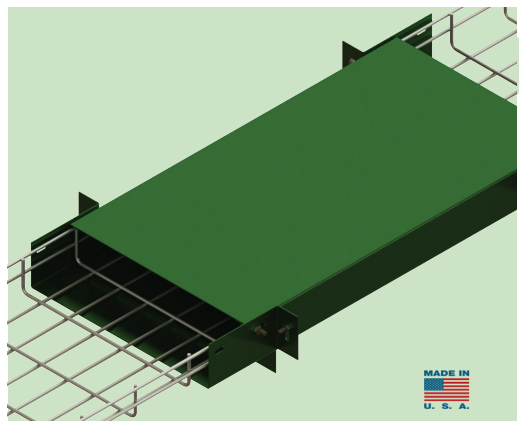
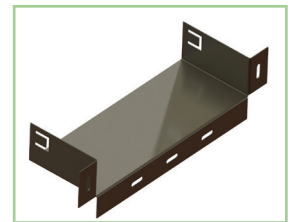

WALL SLEEVE

CAT(H)-(WW)WS

- STANDARD FINISH IS PREGALVANIZED (PG)
- STANDARD USE PER WALL SLEEVE IS:
CH3 (4)
EM-CC (8)
5003-1 (4)
5009-1 (4)

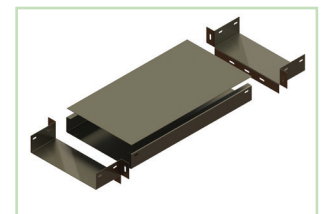

EAGLE BASKET ACCESSORIES

ELEVATION CHANGE KIT

EGL-VERT-KIT

- For supporting and reinforcing elevation changes
- Easy mounting using the LANCE feature to fasten the hinges to the tray
- Contains hardware to set adjustable angle

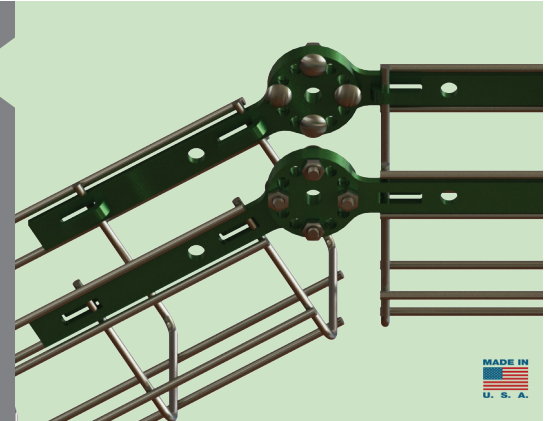

CONDUIT TO BASKET CLIP

EGL-EMT CLIP

- 2 different latching configurations
 - Configuration 1 accommodates ½", ¾" and 1" EMT Connectors
 - Configuration 2 accommodates ½", ¾" and 1-¼" EMT Connectors
- Bottom mounting for all load depth
- Side mounting for 4" and 6" load depth

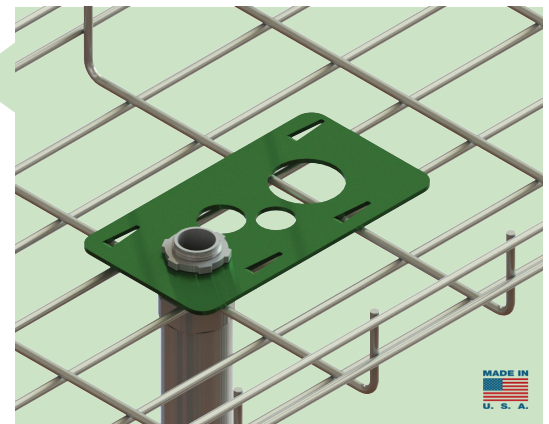

FITTINGS OVERVIEW / ASSEMBLY

Fittings are typically fabricated on the job. However, prefabricated fittings are available upon request. Please contact factory for pricing and availability.

To determine the fitting hardware required to create a set of fittings, please consult our online calculator. [Choose “Wire Basket Component Calculator” from the Resources/ Links drop down menu on www.copecabletray.com homepage]

90° Long Radius Bend

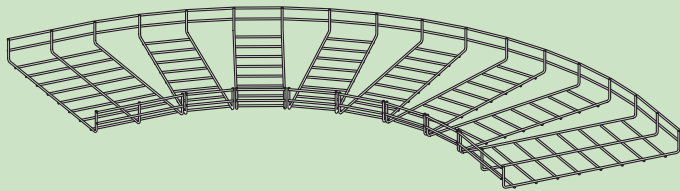

90° Short Radius Bend

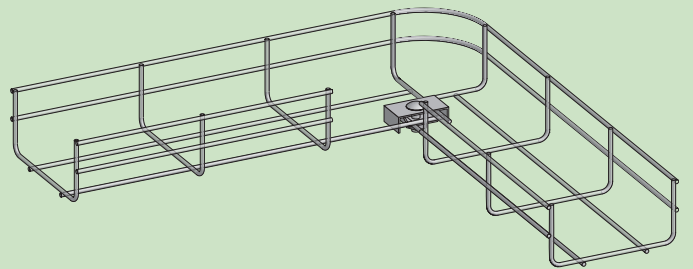

Tee & Cross

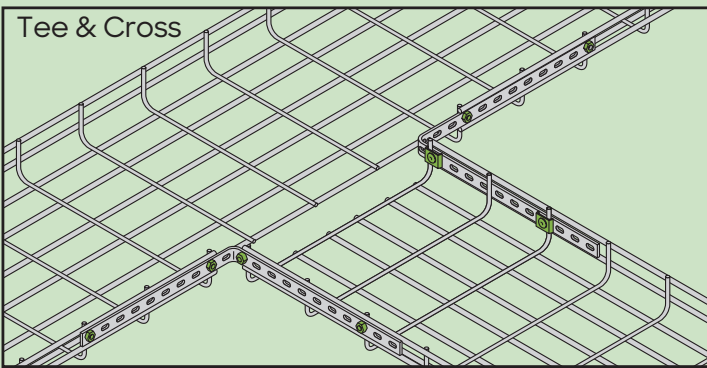

Risers

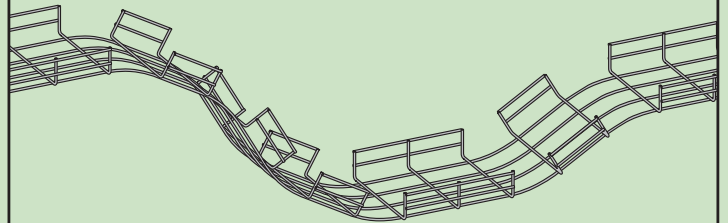

CUTTING TOOL

Fittings can be formed easily on-site by cutting the bottom and side wires. Cut the tray bars on an angle as shown in the illustration.

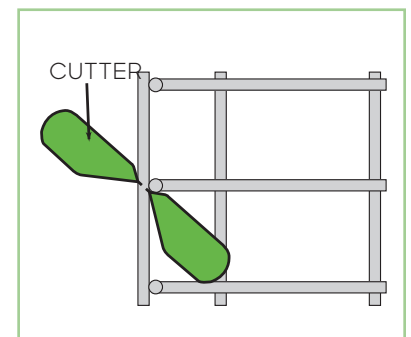
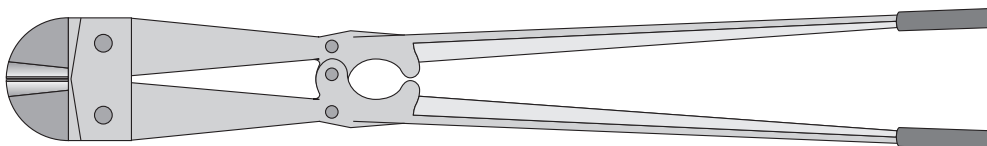

FITTINGS OVERVIEW / ASSEMBLY

90° SHORT RADIUS BENDS

1. CUT THE BOTTOM AND SIDE WIRES

To form 90° bends in the tray, cut out the number of sections shown below based on the width of the tray used



2. ASSEMBLE USING APPROPRIATE HARDWARE

Standard hardware is shown with each bend size

Note: Standard hardware per width of cable tray

- 4"-12" (1) CH1
- 16"-24" (2) CH1

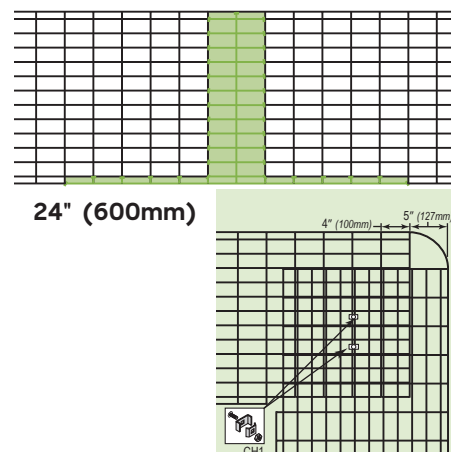
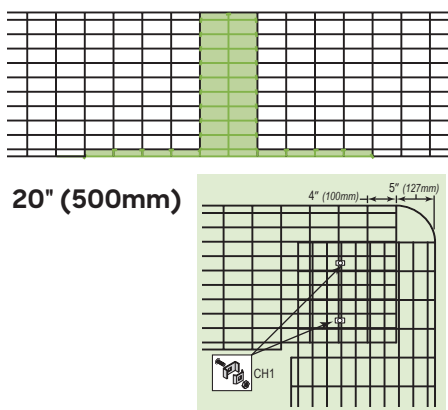
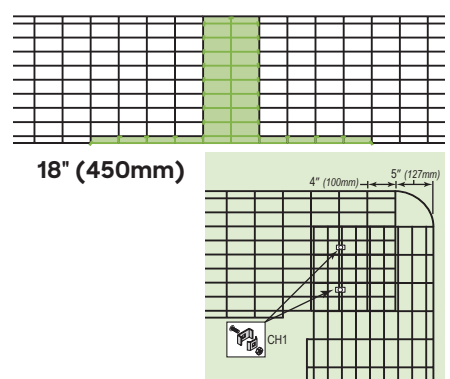
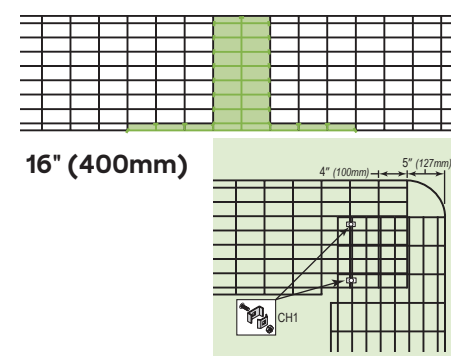
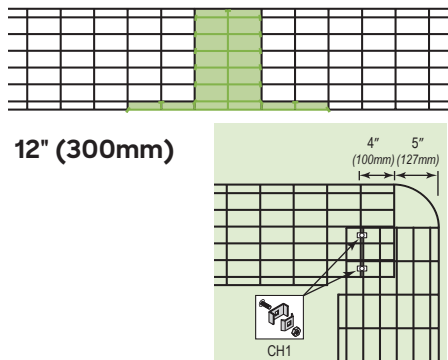
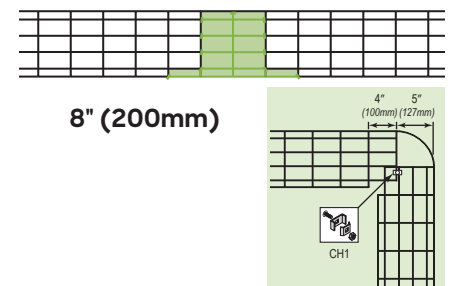
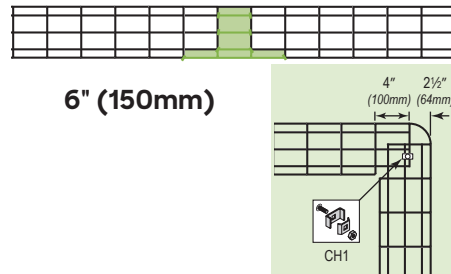
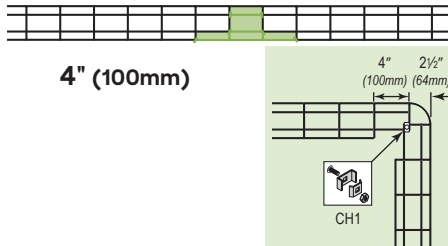

FITTINGS OVERVIEW / ASSEMBLY

90° LONG RADIUS BENDS

1. CUT THE BOTTOM AND SIDE WIRES

- To form 90 bends in the tray, cut out the number of sections shown below based on the width

2. ASSEMBLE USING APPROPRIATE HARDWARE

- Standard hardware is shown

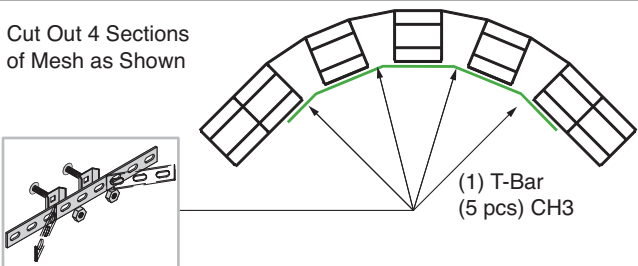
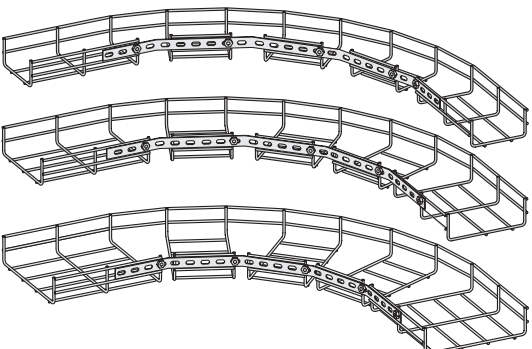
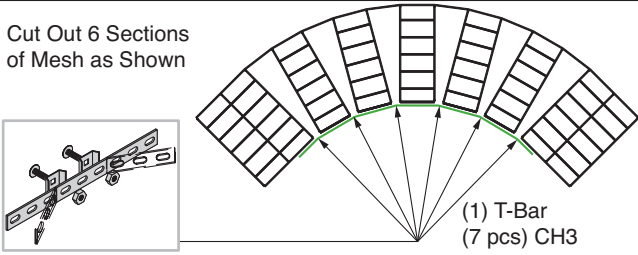
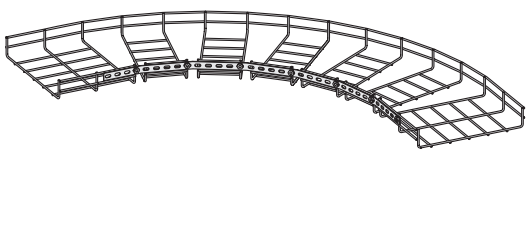
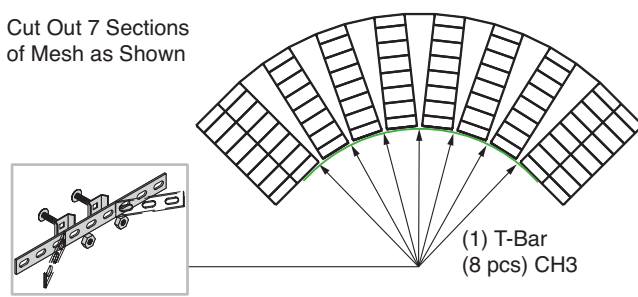
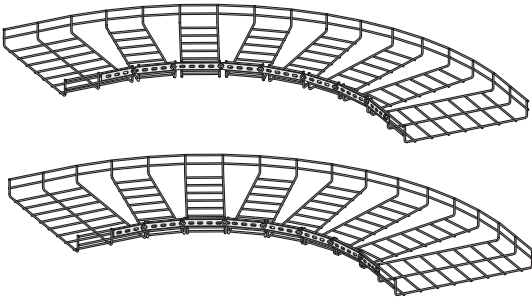
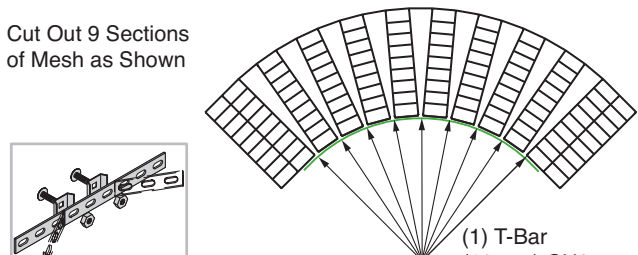
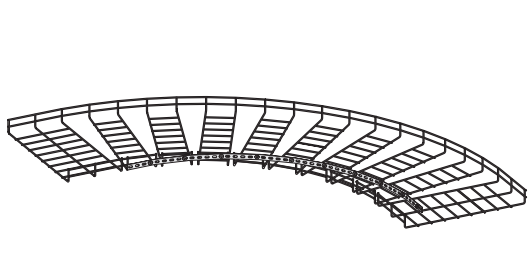
<p>Cut Out 4 Sections of Mesh as Shown</p>  <p>(1) T-Bar (5 pcs) CH3</p>	 <p>EGL2-04 16" Inside Radius</p> <p>EGL2-06 12" Inside Radius</p> <p>EGL2-08 12" Inside Radius</p>
<p>Cut Out 6 Sections of Mesh as Shown</p>  <p>(1) T-Bar (7 pcs) CH3</p>	 <p>EGL2-12 17" Inside Radius</p>
<p>Cut Out 7 Sections of Mesh as Shown</p>  <p>(1) T-Bar (8 pcs) CH3</p>	 <p>EGL2-16 18" Inside Radius</p> <p>EGL2-18 18" Inside Radius</p>
<p>Cut Out 9 Sections of Mesh as Shown</p>  <p>(1) T-Bar (10 pcs) CH3</p>	 <p>EGL2-20 24" Inside Radius</p> <p>EGL2-24 24" Inside Radius</p>

FITTINGS OVERVIEW / ASSEMBLY

STANDARD CROSS

STANDARD HARDWARE PER TEE

- (1) T-BAR (cut in half) or (2) T-BAR-22
- (8) CH3

Note: Always place nut on outside of tray

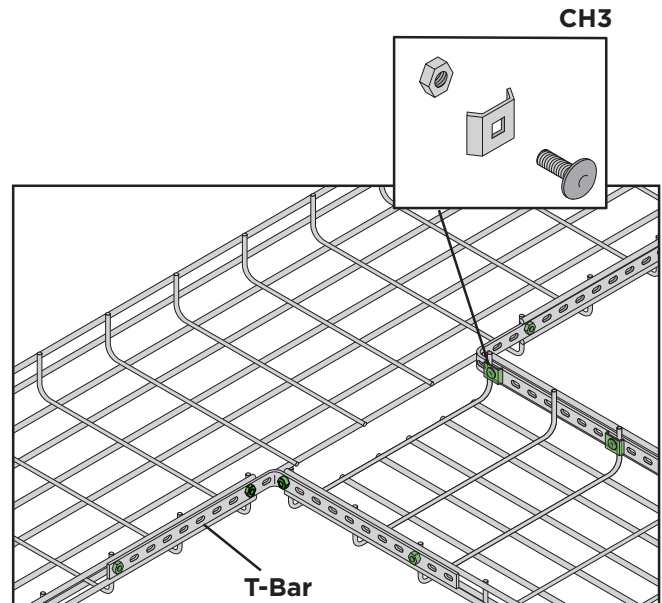
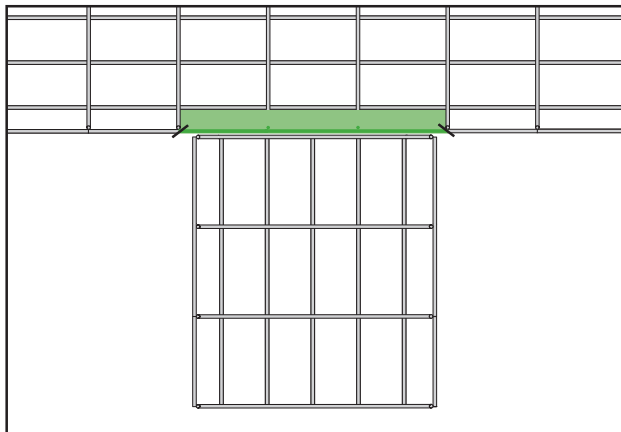

STANDARD CROSS

STANDARD HARDWARE PER CROSS

- (2) T-BAR (cut in half) or (4) T-BAR-22
- (16) CH3

Note: Always place nut on outside of tray

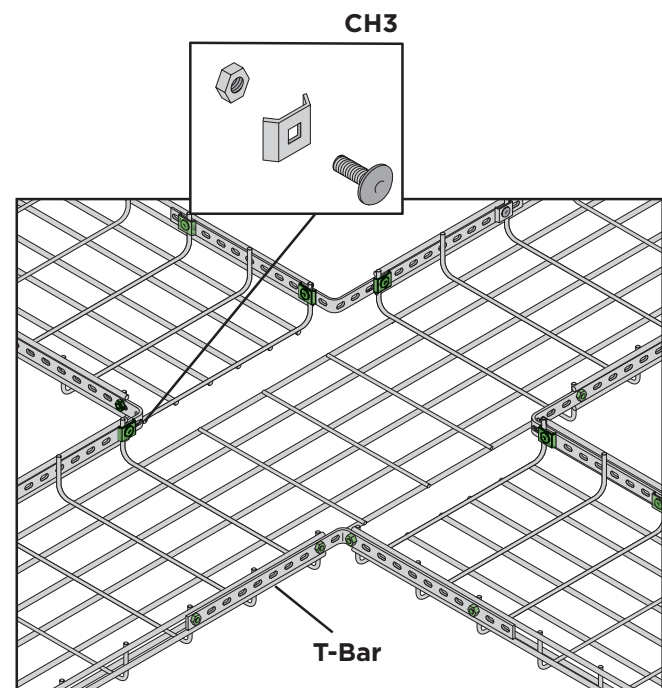
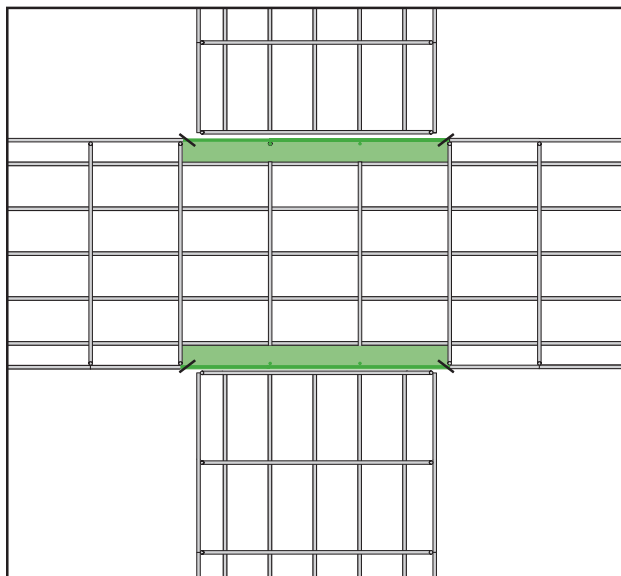

FITTINGS OVERVIEW / ASSEMBLY

REDUCERS AND RISER FITTINGS

STRAIGHT REDUCER & LEFT/RIGHT REDUCER

- Standard hardware per reducer
 - (2) T-BAR
 - (8) CH3
 - (1) CH2

Note: Always place nut on outside of tray

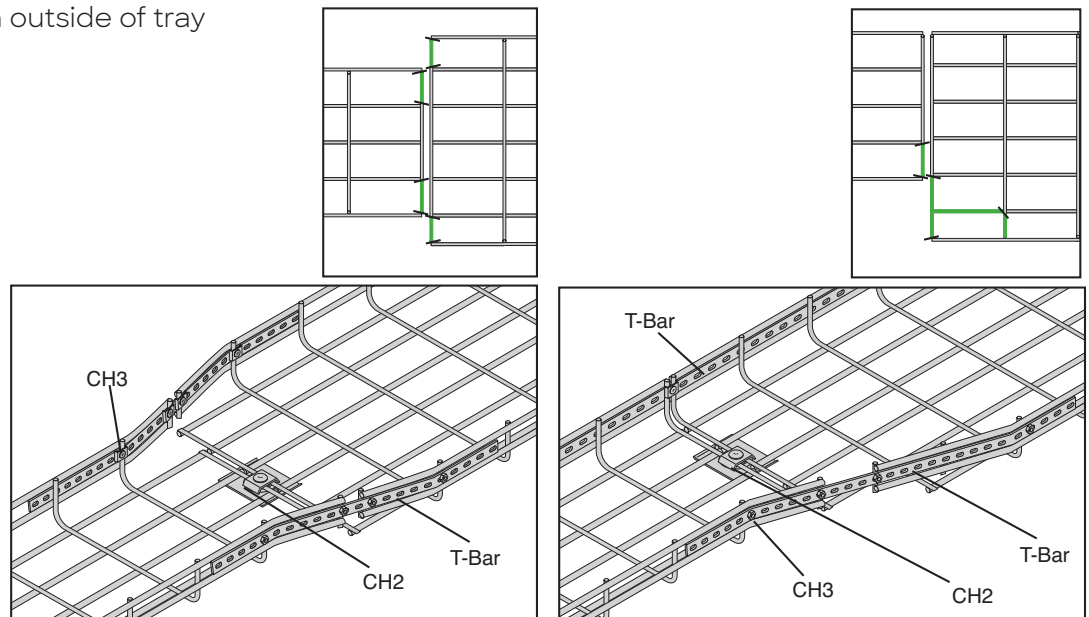

RISER

Risers and drops can be created to avoid different obstacles in the basket path. Simply cut the required number of side mesh sections and bend a vertical riser or drop to fit the application.

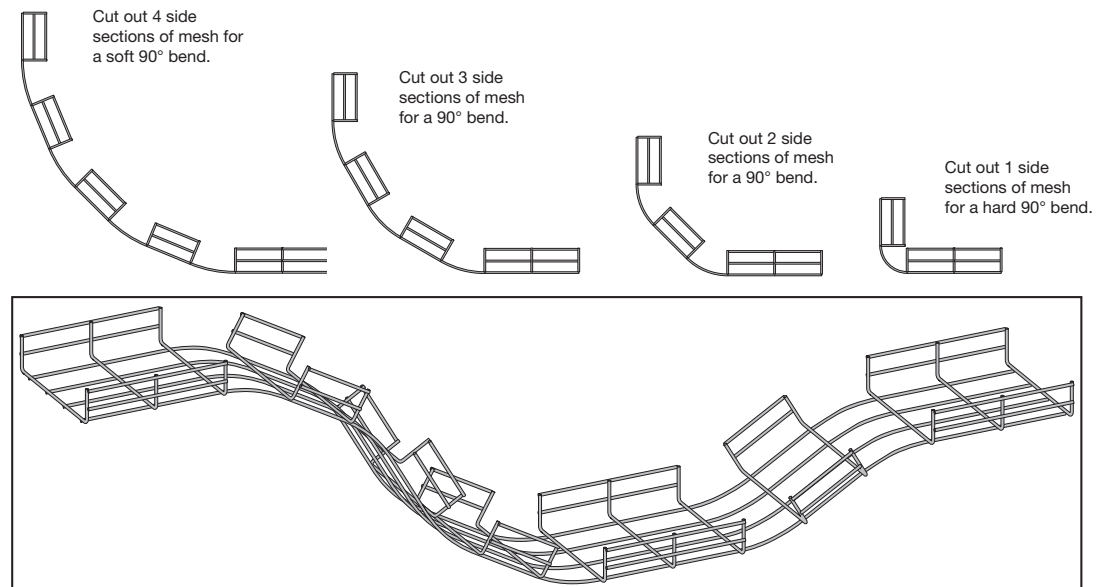



Allied Tube & Conduit ▲ AFC Cable Systems ▲ Heritage Plastics ▲ Unistrut
Unistrut Construction ▲ Cope ▲ US Tray ▲ Calbrite ▲ Calbond ▲ Kaf-Tech
Columbia-MBF ▲ Eastern Wire + Conduit ▲ ACS/Uni-Fab ▲ Cii
Power-Strut ▲ Calconduit ▲ Razor Ribbon ▲ Calpipe Security
Vergokan ▲ Flexicon ▲ Marco

Atkore
1500 Norcom Rd
Philadelphia PA 19154

PHONE / 708-339-16100
TOLL FREE / 800-882-5543

atkore.com/cope

Want to join a company that helps you build
the mindset, skill set and tool set for success?
Visit us at atkore.com/careers